

SANYO

INSTRUCTION MANUAL BASICS

Digital Camera

VPC-X1220EX VPC-X1250 VPC-X1220GX VPC-X1220PX

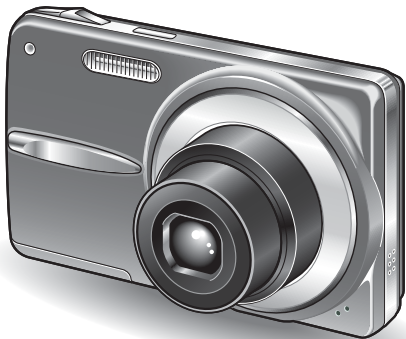

Important note

This manual explains how to safely operate the VPC-X1220EX, VPC-X1250, VPC-X1220GX and VPC-X1220PX.

Any information regarding only one of these products will be labeled as such.

Please read these instructions carefully before using the camera.
Make sure to read and understand the separate booklet "SAFETY MANUAL".
Keep this manual in a safe place for later reference.

Warning

TO PREVENT THE RISK OF FIRE OR ELECTRIC SHOCK, DO NOT EXPOSE THIS APPLIANCE TO RAIN OR MOISTURE

■ FOR AMERICAN USERS

The following advisory is included in accordance with the laws of the State of California (USA):

WARNING:

This product contains chemicals, including lead, known to the State of California to cause cancer, birth defects or other reproductive harm. **Wash hands after handling.**

- This equipment has been tested and found to comply with the limits for a Class B digital device, pursuant to Part 15 of the FCC Rules. These limits are designed to provide reasonable protection against harmful interference in a residential installation. This equipment generates, uses and can radiate radio frequency energy and, if not installed and used in accordance with the instructions, may cause harmful interference to radio communications. However, there is no guarantee that interference will not occur in a particular installation. If this equipment does cause harmful interference to radio or television reception, which can be determined by turning the equipment off and on, the user is encouraged to try to correct the interference by one or more of the following measures:
 - Reorient or relocate the receiving antenna.
 - Increase the separation between the equipment and receiver.
 - Connect the equipment into an outlet on a circuit different from that to which the receiver is connected.
 - Consult the dealer or an experienced radio/TV technician for help.
- Changes or modifications not expressly approved by the party responsible for compliance could void the user's authority to operate the equipment.

Declaration of Conformity

Model number: VPC-X1250

Trade Name: SANYO

Responsible party: SANYO North America Corporation

Address: 21605 Plummer Street, Chatsworth, California 91311

Telephone No.: (818) 998-7322

This device complies with Part 15 of the FCC Rules. Operation is subject to the following two conditions:

- (1) this device may not cause harmful interference, and
- (2) this device must accept any interference received, including interference that may cause undesired operation.

FOR USERS IN THE USA

About the battery charger

IMPORTANT SAFETY INSTRUCTIONS – SAVE THESE INSTRUCTIONS DANGER – TO REDUCE THE RISK OF FIRE OR ELECTRIC SHOCK, CAREFULLY FOLLOW THESE INSTRUCTIONS

- For connection to a supply not in the U.S.A., use an attachment plug adapter of the proper configuration for the power outlet.
- **Power Supply Cord:**
Use UL Listed detachable power supply cord - No. 18 AWG, two conductors, rated 10 A, VW-1, 105 °C, 125/250 V, minimum 1.8 m, maximum 3 m long. Provided with a molded-on, non-polarized attachment plug with a 15 A, 250 V (NEMA 2-15P) configuration or a 15 A, 125 V (NEMA 1-15P) configuration and a molded-on connector which mates with the Power Inlet.

Cord Type

Basic Cord Type	Other Suitable Types
TS	TST
SP-2	SPE-2, SPT-2
SP-3	SPE-3, SPT-3
SV	SVE, SVO, SVOO, SVT, SVTO, SVTOO
SJ	SJE, SJO, SJOO, SJT, SJTO, SJTOO
S	SE, SO, SOO, ST, STO, STOO

- This device complies with Part 15 of the FCC Rules. Operation is subject to the following two conditions: (1) this device may not cause harmful interference, and (2) this device must accept any interference received, including interference that may cause undesired operation.

PARA LOS USUARIOS DE EE.UU.

Acerca del cargador de baterías

INSTRUCCIONES IMPORTANTES SOBRE DE SEGURIDAD - GUARDE ESTAS INSTRUCCIONES PELIGRO - PARA REDUCIR EL RIESGO DE INCENDIO O DESCARGAS ELÉCTRICAS, SIGA CUIDADOSAMENTE ESTAS INSTRUCCIONES

- Para la conexión a una red de alimentación que no sea de EE.UU., utilice el adaptador de enchufe apropiado para la toma de la red.
- **Cable de alimentación:**
Utilice el cable de alimentación UL desenchufable indicado en la lista - N.º 18 AWG, dos conductores, amperaje nominal de 10 A, VW-1, 105 °C, 125/250 V, mínimo 1,8 m, máximo 3 m de longitud. Provisto de enchufe moldeado, adaptador de enchufe no polarizado con configuración de 15 A, 250 V (NEMA 2-15P), o configuración de 15 A, 125 V (NEMA 1-15P) y conector moldeado que se adapta a la toma de corriente de la red.

Tipo de cable

Tipo de cable básico	Otros tipos adecuados
TS	TST
SP-2	SPE-2, SPT-2
SP-3	SPE-3, SPT-3
SV	SVE, SVO, SVOO, SVT, SVTO, SVTOO
SJ	SJE, SJO, SJOO, SJT, SJTO, SJTOO
S	SE, SO, SOO, ST, STO, STOO

- Este dispositivo cumple con lo estipulado en la Parte 15 de las Normativas de la FCC. La operación está sujeta a las dos condiciones siguientes: (1) este dispositivo no puede provocar interferencias nocivas, y (2) este dispositivo debe aceptar las interferencias recibidas, incluidas las interferencias que puedan provocar un funcionamiento no deseado.

■ FOR CANADIAN USERS

- This Class B digital apparatus complies with Canadian ICES-003.

■ FOR EU USERS

The symbol mark and recycling systems described below apply to EU countries and do not apply to countries in other areas of the world.

Your SANYO product is designed and manufactured with high quality materials and components which can be recycled and/or reused.

The symbol mark means that electrical and electronic equipment, batteries and accumulators, at their end-of-life, should be disposed of separately from your household waste.

Note:

If a chemical symbol is printed beneath the symbol mark, this chemical symbol means that the battery or accumulator contains a heavy metal at a certain concentration. This will be indicated as follows: Hg: mercury, Cd: cadmium, Pb: lead

In the European Union there are separate collection systems for used electrical and electronic equipment, batteries and accumulators.

Please, dispose of them correctly at your local community waste collection/ recycling centre.

Please, help us to conserve the environment we live in!



SANYO Sales & Marketing Europe GmbH

Stahlgruberring 4, D-81829 München, Germany

SANYO Electric Co., Ltd.

1-1, Sanyo-cho, Daito City, Osaka 574-8534, Japan

■ FOR RUSSIAN USERS



AP46

This product is certified by an official certification company which is authorized by the Russian Federation.

HOW TO READ THIS MANUAL

This instruction manual for your camera is organized into the following sections.

■ SETUP

Before taking pictures with your camera, you will need to familiarize yourself with a few of its functions and complete some setup steps.

■ BASIC OPERATION

An explanation of the fundamental operation for capturing images and viewing images.

■ APPENDICES

The camera specifications are found here.

■ Symbols used in this manual

HINT Points giving some extended instructions or special points to pay attention to.

CAUTION Points that require special attention.

(page xx) Refer to the page indicated for detailed information.

You may find the answers to questions or problems concerning camera operation in the ADVANCED INSTRUCTION MANUAL.

For information concerning how to use the accompanying CD-ROM (SANYO Software Pack), please see the file "SANYO Software Pack INSTRUCTION MANUAL."

■ How to view the "INSTRUCTION MANUAL: ADVANCED" and "SANYO Software Pack INSTRUCTION MANUAL" files

- ① Insert the CD-ROM (SANYO Software Pack) that was included with your camera in your computer's CD-ROM drive.
- ② Install the Adobe Reader 9 on your computer.
- ③ On the installation screen, click on "Instruction Manuals (PDF)".
- ④ Click on the desired instruction manual.

SHOOT, PLAY BACK AND SAVE

Install the battery pack

1 Use the supplied charger to charge the battery pack.

- The CHARGE indicator is lit during charging.
- The CHARGE indicator will turn off when the battery pack is fully charged.
- Charging takes approximately 120 min.

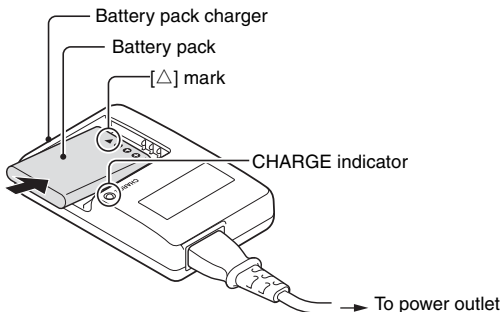

2 Open the battery/card compartment cover, and insert the battery pack.

- The battery/card compartment cover is located on the bottom of the camera.
- Press the ON/OFF button to turn the camera on.

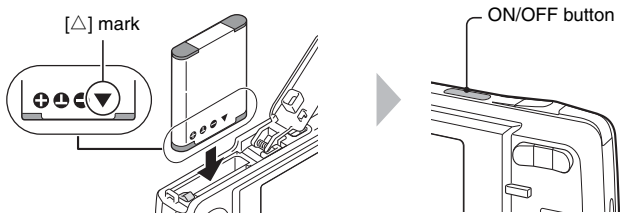

SHOOT, PLAY BACK AND SAVE

Before capturing those important shots, be sure to first take a test shot to confirm that your camera is set up and ready to go

- Sanyo declines any claim for compensation for recorded contents etc. in case of photographing or recording failure due to a chance camera or card flaw.

Shooting

- 1 Press the [▶] button.**
 - The recording mode menu appears.

Single-shot

High-speed sequential shots

Sequential shots

Video clip recording



Shutter button [◀] / [▶] buttons

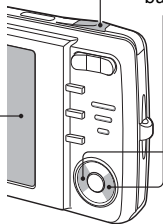

- 2 Press the [◀] or [▶] button to select the recording mode.**

- 3 Press the SET button.**
 - The recording mode is indicated by an icon in the upper left area of the monitor.

- 4 Press the shutter button.**

Single-shot mode:
A still image is captured.

High-speed sequential shots mode/sequential shots mode:
Shooting begins. Release the shutter button to discontinue shooting.

Video clip recording mode:
Recording begins. To stop recording, press the shutter button again.

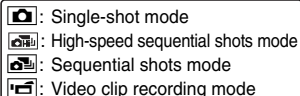

<Recording mode>

Playback

■ Still image playback

- 1 Press the playback button [▶].**
 - The display switches to the Playback Screen.
 - To view other images, press the [◀] or [▶] button.
 - If the playback button [▶] is pressed, the display returns to the Shooting Screen.

■ Video clip playback

- 1 Press the playback button [▶].**
 - The display switches to the Playback Screen.
 - Press the [◀] or [▶] button to display the video clip you wish to play back.
- 2 Press the SET button.**
 - Playback of the selected video clip begins.
 - If the playback button [▶] is pressed again, the display changes to the Shooting Screen.

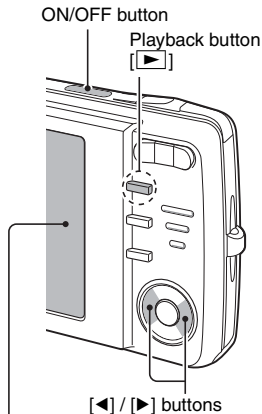

<Example: After recording a video clip>

When you are finished taking pictures...

Press the ON/OFF button to turn the camera off.

SHOOT, PLAY BACK AND SAVE

Copying files to a computer (Windows XP)

1 Install the software.

- ① Insert the CD-ROM (SANYO Software Pack) that was included with your camera in your computer's CD-ROM drive.
 - The installation screen appears.
- ② Click on [ArcSoft MediaImpression 2] in the installation screen.
 - Follow the messages on your computer screen to install the software.

2 Use the supplied USB interface cable to connect your camera to the computer.

- Connect the camera's USB/AV terminal to the computer's USB connector.
- The USB Connection Screen appears on the camera's monitor.

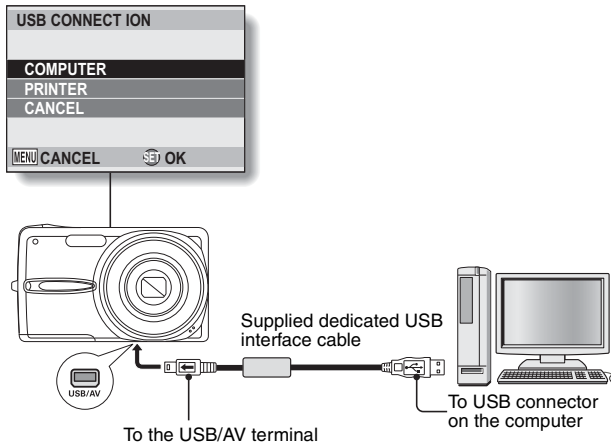

-
- 3** Select “COMPUTER”, and press the SET button.
- The screen to select the connection mode appears.

-
- 4** Select “CARD READER”, and press the SET button.
- The camera is connected in the card reader mode.
 - If the Windows automatic playback screen appears on the computer monitor, close it.

-
- 5** Double-click on the desktop [MediaImpression 2] icon to launch MediaImpression 2.
- The MediaImpression 2 home page appears.

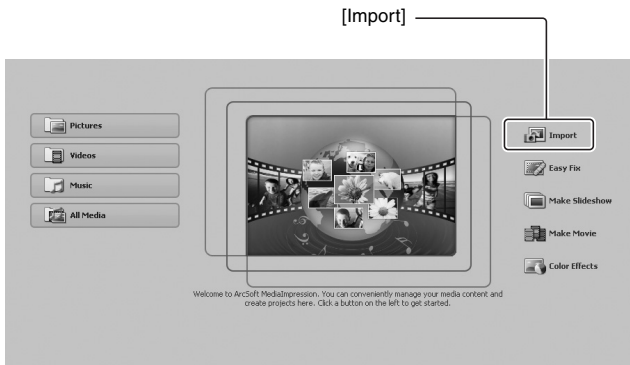

SHOOT, PLAY BACK AND SAVE

6 Click on [Import].

- The files in the camera are shown on the import screen.

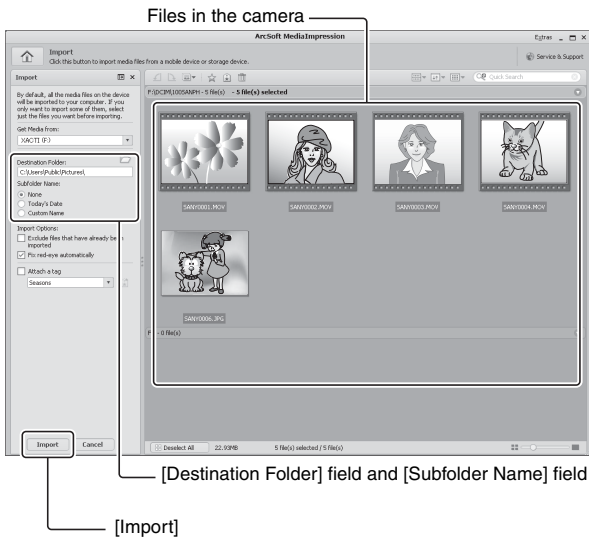

HINT

You can specify which folder to copy the files to.

- When you click on the folder icon in the [Destination Folder] field, the screen to specify the copy destination appears.
- We suggest that you click on [○Today's Date] in the [Subfolder Name] field to select it. When [○Today's Date] is selected, a subfolder named with the current date is automatically created in the folder specified in the [Destination Folder] field, and the files are copied to it.

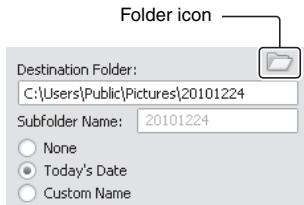

7 Click on [Import].

- The files in the camera are copied to the computer.

8 When copying is completed, click on [Done].

- You are returned to the Medialmpression 2 home page.

9 Click on the close button to exit Medialmpression 2 and end the program.

HINT

More about Medialmpression 2

- On the Medialmpression 2 home page, click on [Service & Support] for more information.

SHOOT, PLAY BACK AND SAVE

Dismounting the camera

CAUTION

- To disconnect your camera, be sure to follow the procedure below. Failure to follow this procedure may cause faulty operation of your computer or loss of card data.

1 Left-click on the icon for safely removing hardware.

- A list appears showing the devices connected to the computer's USB connectors.

<Windows Vista>

- Close the window.

2 Left-click on the camera drive (E:).

- The camera can now be disconnected.
 - * The drive name (E:) may be different on your computer.

CAUTION

Insert and pull out the cable carefully

- When connecting the cables, make sure that the cable plugs are correctly oriented and that they match the shapes of the terminal sockets on the devices. Push the plugs in straight when connecting them. If undue force is used to connect a cable, it may permanently damage the connector pins in the terminal socket.
- Do not use excessive force when connecting and disconnecting cables.
- Please connect the dedicated USB interface cable to your computer's USB connector. Do not connect it to the USB port on your monitor or keyboard, or to the USB hub. Be especially careful when installing the driver software. In some instances, it may not be possible to correctly install the driver software.

To access the data in the camera's internal memory...

- Remove the card from the camera.

CONTENTS

CONTENTS	1
CHECKING THE INCLUDED ACCESSORIES	3
Attaching the handstrap	4
Media cards that can be used with this camera	4
What "card" means in this manual	4
Installing/removing the DC adaptor (Model VAR-A3: sold separately)	5

■ SETUP

PARTS NAMES	6
CHARGING THE BATTERY PACK	8
Charging the battery pack	9
INSTALL THE BATTERY PACK AND CARD	12
Installation	12
To format a card	14
Warning concerning battery pack temperature	15
TURNING THE CAMERA ON AND OFF	16
Turning on the camera	16
Turning off the camera	16
About the auto power off function	17
DATE AND TIME SETTING	18

■ BASIC OPERATION

BEFORE TAKING PICTURES	21
Switching between the recording mode and playback mode	21
How to switch the recording mode	22
Switching the display mode	23
Adjust the monitor brightness	24
Hints for taking pictures	25
CAPTURING AND PLAYING BACK STILL IMAGES	26
Shooting single shots	26
Shooting sequential shots	28
Viewing still images	30
9-image/20-image display playback	31
Folder playback	32
Magnifying (zooming in) the image	33
Zoom jump playback	34
Deleting files	35

VIDEO CLIP RECORDING AND PLAYBACK	37
Recording a video clip	37
Playing back the video clip	38
USING THE SCENE FUNCTION	41
Capture a still image with a voice memo	43
How to use the best shot feature	44
How to use the face chaser feature	45
How to shoot using Smile Detection	46
OTHER RECORDING FUNCTIONS	48
Using the zoom	48
Flash setting	50
Self-timer	52
Focus range	54
ACCESSING THE MENU	57
How to display the menus	57
How to operate the menus	58

■ APPENDICES

SPECIFICATIONS	59
Camera	59
Camera connectors	62
Battery life	62
Possible Number of Images/Video Recording Time/ Audio Recording Time	63
Supplied battery pack charger	64
Supplied Li-ion battery pack	64
Others	65
Before capturing those important shots, be sure to first take a test shot to confirm that your camera is set up and ready to go	66

CHECKING THE INCLUDED ACCESSORIES

- Handstrap: 1

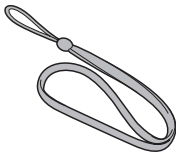

- SANYO Software Pack (CD-ROM): 1

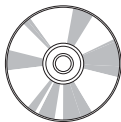

- Lithium-ion battery pack (battery pack): 1

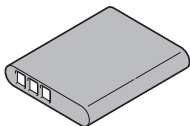

- Lithium-ion battery pack charger and power cord

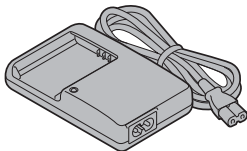

- Dedicated USB interface cable: 1

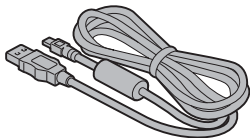

- Dedicated AV interface cable: 1

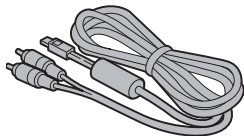

- SAFETY MANUAL (safety precautions booklet)
Please read this booklet carefully before using the digital camera.



- QUICK GUIDE

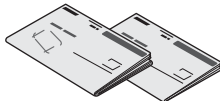

- INSTRUCTION MANUAL BASICS (VPC-X1220EX, VPC-X1220GX, VPC-X1220PX only)

Attaching the handstrap

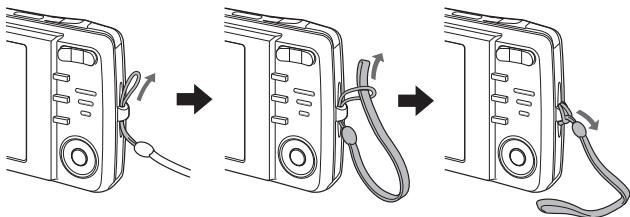

Media cards that can be used with this camera

The types of card that can be inserted into and used with this camera are:

- SD Memory Card
- SDHC Memory Card

What “card” means in this manual

- In this manual, SD Memory Cards and SDHC Memory Cards that can be used in this digital camera are referred to as “card”.

CHECKING THE INCLUDED ACCESSORIES

Installing/removing the DC adaptor (Model VAR-A3: sold separately)

Install in the camera's battery slot, and connect the AC adaptor. Use in conjunction with the AC adaptor.

Attaching the DC adaptor

- 1 Open the camera's battery/card compartment cover.

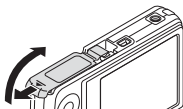

- 2 Insert the DC adaptor into the battery slot.
 - Make sure that the DC adaptor is correctly oriented when inserting, and insert it firmly all the way.

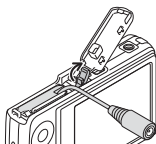
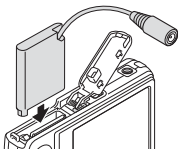

- 3 Close the battery/card compartment cover.

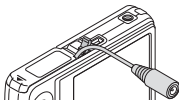

- 4 Connect the AC adaptor.

Removing the DC adaptor

- 1 Turn off the camera.
- 2 Remove the AC adaptor.
- 3 Open the camera's battery/card compartment cover, and remove the DC adaptor.

PARTS NAMES

Front

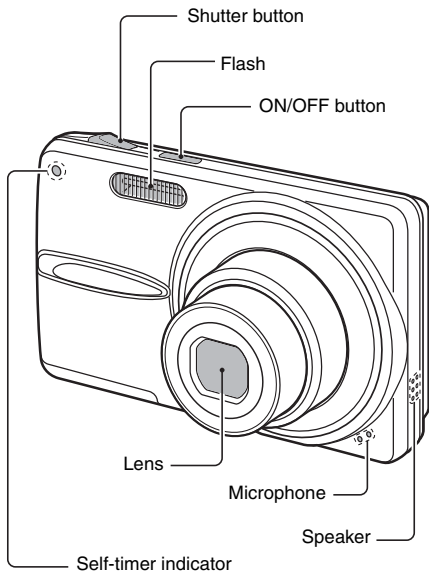

Bottom

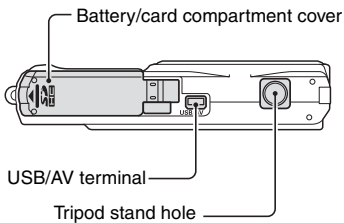

PARTS NAMES

Rear

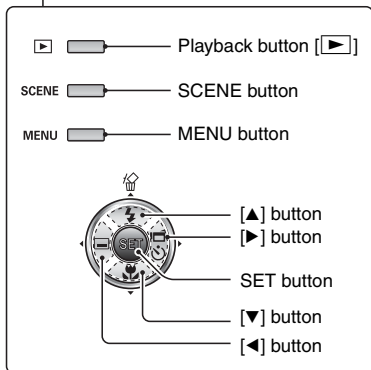
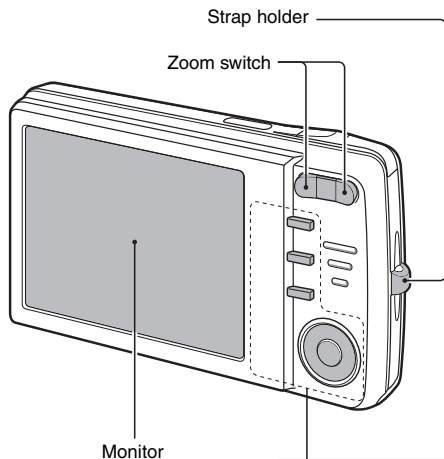

CHARGING THE BATTERY PACK

Please charge the supplied battery pack before using it.

- 1** Connect the supplied power cord to the socket on the battery pack charger.

- Insert the connector straight and securely.

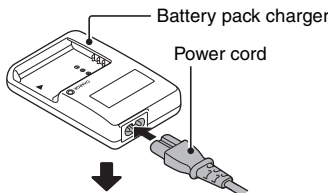

- 2** Insert the battery pack in the battery charger.

- Insert it in the direction indicated by the [Δ] mark on the battery pack.

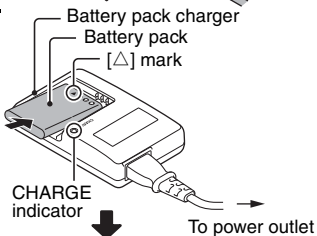

- 3** Plug the power plug into a power outlet (AC 100 V to 240 V).

- Charging begins.
- The CHARGE indicator is lit during charging.

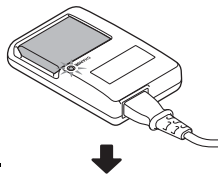

- 4** When the CHARGE indicator turns off, unplug the power cord from the power outlet, and remove the battery pack from the charger.

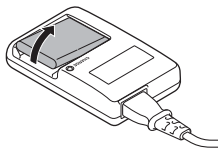

HINT

- Charging takes approximately 120 min.

CHARGING THE BATTERY PACK

Charging the battery pack

Be sure to fully charge the supplied or separately sold battery pack before using it in your camera. For charging the battery pack, use the supplied charger.

Charge the battery pack if it is being used for the first time, and recharge it whenever the remaining charge is low.

Does the battery pack feel hot?

- During charging, the charger and battery pack will be warm. This is normal and does not indicate a malfunction.

If there is interference to your TV or radio during charging...

- Move the battery pack and charger further away from the TV or radio.

Ambient temperature during charging

- It is recommended that the ambient temperature during charging be between about 10 °C and 35 °C (50 °F and 95 °F). Due to the characteristics of the battery pack, at temperatures below 0 °C (32 °F), it may not be possible to sufficiently charge it.
- When the battery pack temperature is high, the safety function may be activated and halt charging.

Charge a battery pack in the following cases

- A battery pack which has not been used for a long time
- Newly purchased battery pack

FOR AMERICAN USERS:

- Use a UL Listed, 1.8 to 3 m (6 to 10 ft.), Type SPT-2 or NiSPT-2, AWG No.18 power supply cord, rated for 125 V 7 A, with a non-polarized NEMA 1-15P plug rated for 125 V 15 A.

About the CHARGE indicator

The CHARGE indicator shows the status of the battery pack and the charger. Please refer to the following table if the indicator flashes abnormally.

CHARGE indicator	
Not lit	Not connected properly <ul style="list-style-type: none">• To recharge the battery pack, the power cord of the charger must be connected to a power outlet, and the plug at the other end inserted in the charger's power socket (page 8).• The battery pack is not installed, or it is not installed correctly (page 8). Charging finished
Lit	Charging
Flashing	Problem with the battery pack or battery pack charger <ul style="list-style-type: none">• Immediately remove the battery pack from the charger.• Do not use an abnormal battery pack. (The usable life of the battery pack has probably expired.)

CAUTION

Do not charge the battery pack immediately after the camera has been in continuous use for a long time

- The battery pack becomes hot when the camera is used continuously for a long time. If you attempt to charge the battery pack in this state, the safety function may be activated and it may not be possible to charge the battery pack. Wait until the battery pack has cooled down before attempting to charge it.

Does the battery pack appear swollen?

- The lithium-ion battery used in this camera may expand slightly when stored in a hot environment or repeatedly used, but this is not a safety hazard.

CHARGING THE BATTERY PACK

HINT

About the internal backup battery

- This camera's internal battery serves to maintain the date and time settings, as well as the shooting settings. The backup battery will be fully charged when the battery pack is kept in the camera continuously for about 2 days. In the fully charged state, the backup battery will maintain the camera settings for about 7 days.

When not using the camera for a long time, remove the battery pack

- A small amount of power is still used even if the digital camera is turned off, and it is therefore recommended that the battery pack be removed from the camera if it is not going to be used for a long time. Note that when the battery pack is removed for a long period, the time and date settings may be cleared. Before using your camera again, be sure to confirm that the camera settings are correct.

To prolong the life of the battery pack

- Although the battery pack is an expendable item, you can maximize the life of the battery by heeding the following suggestions.
 - Do not leave the battery under the hot summer sun or exposed to other high-temperature environments.
 - Do not continually recharge the battery when it is already fully charged. After fully charging it once, for example, use it for a while to partially discharge it before charging it again.
 - When the battery is not to be used for a long time, if possible store the partially charged (not fully charged) battery in a cool environment.

INSTALL THE BATTERY PACK AND CARD

Installation

- Make sure that the battery pack and card orientation are correct.
- The card can be used after it has been formatted with the camera.

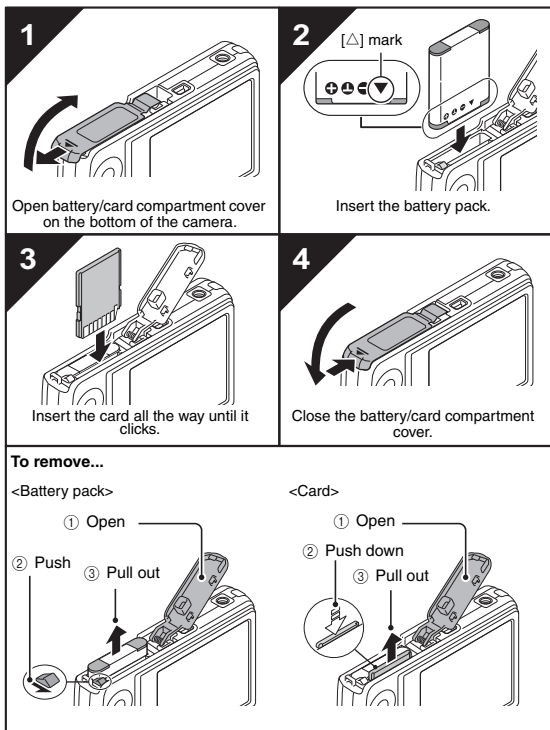

INSTALL THE BATTERY PACK AND CARD

CAUTION

Do not remove the battery pack outer covering or label

- Do not use the battery with the outer covering or label removed, as doing so may result in malfunction.

Be careful when removing the card

- Do not attempt to forcibly remove the card.
- Never remove the card when the camera is connected to a computer or printer, or when the self-timer indicator is flashing quickly. In doing so, you risk losing the data stored in the card.

Keep your finger on the card until it is completely inserted or released

- If you remove your finger too soon, the card may spring out and become lost or hit someone in the eye.

HINT

Shooting without a card installed

- When a card is installed, images are recorded to and played back from the card. When no card is installed, images are recorded to and played back from the camera's internal memory. When the camera is turned on with no card installed, the internal memory icon  is shown on the monitor to let you know that the images you capture will be saved to the camera's internal memory.

To format a card

1 Install the card in the camera. Turn on the camera (pages 12 and 16).

2 Display the menu (page 57).

3 Display the Option Menu (page 58).

4 Select “FORMAT” and press the SET button.

- The Format Screen appears. Follow the instructions on the screen to format the card.

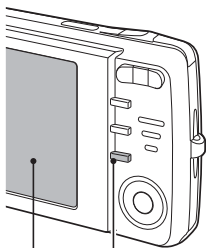

MENU button

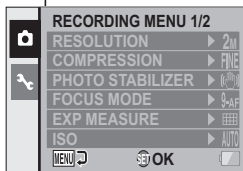

INSTALL THE BATTERY PACK AND CARD

Warning concerning battery pack temperature

- If the battery pack in the camera becomes too hot, a blinking temperature warning icon  will appear on the monitor. If the blinking icon does appear, the camera should be turned off as soon as possible and the battery pack allowed to cool before the camera is turned on again.
- Note that the camera will turn off automatically if it continues to be used with the battery pack temperature elevated.

TURNING THE CAMERA ON AND OFF

Turning on the camera

In the recording mode

- 1 Press the **ON/OFF** button.
 - The camera turns on.
 - The camera turns on in the recording mode that was active before it was last turned off.

In the playback mode

- 1 Press the playback button [▶] for at least one second.
 - The Playback Screen appears on the monitor (pages 30 and 38).

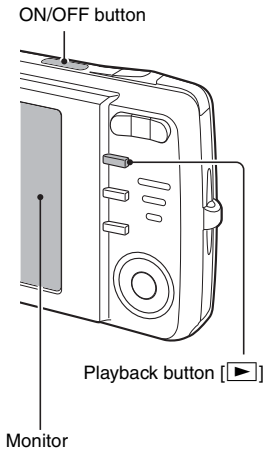

Turning off the camera

- 1 Press the **ON/OFF** button.
 - The camera turns off.

<If the camera was turned on by pressing the playback button [▶]>

 - When the playback button [▶] or ON/OFF button is pressed, the camera turns off.

TURNING THE CAMERA ON AND OFF

About the auto power off function

In order to preserve battery pack power when, for example, the camera has accidentally been left on, the camera is furnished with an “auto power off” function by which the camera automatically turns off after a certain period of inactivity (about 1 minute during shooting or about 3 minutes during playback [factory default settings]).

- If the auto power save function has operated to turn the camera off, press the ON/OFF button to turn it back on.
- You can change the setting for the time elapsed before the camera automatically turns off.
- When the camera is connected to a computer or printer using the dedicated USB interface cable, the auto power save function is disabled, and the camera turns off after about 12 hours.

HINT

If the  icon appears...

- When a picture is taken, the date and time it was captured is recorded with it. When the date and time cannot be recorded with the image because the date and time have not yet been set (page 18), the  icon appears. To have the date and time recorded with images, please make this setting before capturing images.

DATE AND TIME SETTING

The camera will record the date and time an image or audio recording is taken so that you can display them during playback. Therefore, before capturing images, make sure the correct date and time are set.

* To correct the date and time setting, please see under **HINT** on page 20.

Example: To set the clock to 7:30 p.m. on December 24, 2010

1 Turn on the camera (page 16), and press the SET button.

- The Clock Set Screen appears.
- Follow the procedures below to enable or disable the date display during playback, to set the display format for the date, and to set the date and time.
- To display the Recording or Playback Screen, press the MENU button 2 times.

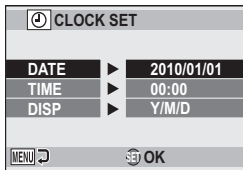

2 Set the date.

- ① Select "DATE".
- ② Press the SET button.
 - The Set Date Screen appears.
- ③ Set the date to "2010/12/24".
 - The date is set in the following order: Set the year → Set the month → Set the day.
 - Press the [◀] or [▶] button to select year, month or day. Press the [▲] or [▼] button to increase or decrease the number.
- ④ Press the SET button.

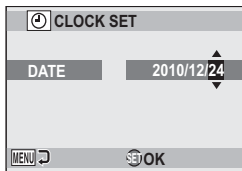

DATE AND TIME SETTING

3 Set the clock.

- ① Select "TIME".
- ② Press the SET button.
 - The Set Time Screen appears.
- ③ Set the time to "19:30".
 - The time is set in the following order: Set the hour → Set the minute.
 - A 24-hour clock is used for the time display.
- ④ Press the SET button.

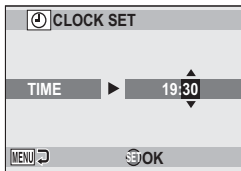

4 Set the order in which the date is displayed during playback.

- ① Select "DISP".
- ② Press the SET button.
 - The Set Date Format Screen appears.
- ③ Press the [▲] or [▼] button.
 - Press the [▲] button to change the displayed date order as follows:

→ Y / M / D → M / D / Y → D / M / Y →

Press the [▼] button to change it in the reverse order.

- ④ Press the SET button.

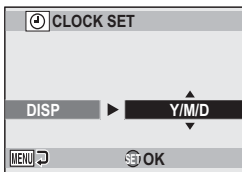

5 Press the MENU button.

- The date and time setting is completed.
- To display the Recording or Playback Screen, press the MENU button.

HINT

About the settings backup

- Under normal conditions, while the battery pack is being replaced, an internal battery will maintain the date and time settings. However, there is a small chance the settings may be lost (the backup will last for about 7 days). It is recommended to check that the date and time settings are still correct after replacing the battery pack and before shooting or recording of any type (follow step 1).

To correct the date and time settings

- ① Turn on the camera, and press the MENU button.
- ② Select the [] tab, and press the SET button.
- ③ Select "CLOCK SET" and press the SET button.
 - The screen to set the date and time appears.
 - The current date and time settings are shown.
- ④ Select the line you wish to change, and make the correction.

BEFORE TAKING PICTURES

Switching between the recording mode and playback mode

Switch between shooting and playing.

- 1 Press the **ON/OFF** button to turn the camera on.

- 2 Press the **playback button** [▶].
 - Each time the playback button is pressed, the camera switches between the recording mode and the playback mode.

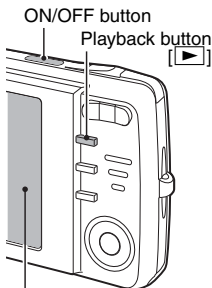

<Recording mode>



<Playback mode>

HINT

To turn the camera on in the **playback mode**

- Press the playback button [▶] for at least 1 second, and the camera will turn on in the playback mode.

How to switch the recording mode

Your camera can capture single still photos (single-shot mode), record video clips (video clip recording mode), and also capture a series of still photos (sequential shots mode).

1 Press the **ON/OFF** button to turn the camera on.

2 Press the **[▶]** button.

- The screen to set the recording mode and the self-timer appears.

3 Press the **[▶]** button to select the recording mode.

4 Press the **SET** button.

- The selected recording mode is set.
- An icon in the upper left area of the monitor indicates the active recording mode setting.

ON/OFF button

[▶] button

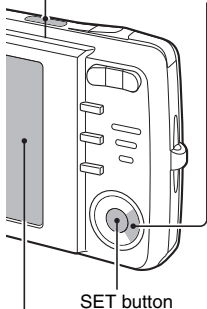

SET button



<Recording mode>

- : Single-shot mode
- : High-speed sequential shots mode
- : Sequential shots mode
- : Video clip recording mode

BEFORE TAKING PICTURES

Switching the display mode

In the recording mode, you can select either the “settings display mode” which allows you to confirm the shooting settings on the monitor while you shoot, or the “normal display mode” in which the setting indications are turned off, providing a full view of the subject.

- 1 Press the ON/OFF button to turn the camera on.**

- 2 Press the SET button.**
 - Each time the SET button is pressed, the camera switches between the settings display mode and the normal display mode.

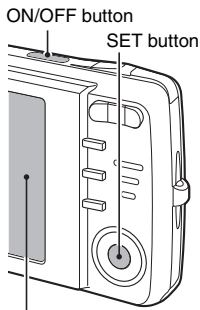

Adjust the monitor brightness

The brightness of the monitor is adjustable. Adjust the brightness to the optimum readability in the ambient light.

- 1 Press the ON/OFF button to turn the camera on.**
- 2 Press the MENU button for at least 1 second.**
 - The monitor brightness menu appears.
- 3 Press the [◀] and [▶] buttons to adjust the brightness.**
- 4 Press the MENU button.**
 - The monitor brightness is set, and the monitor brightness menu is canceled.

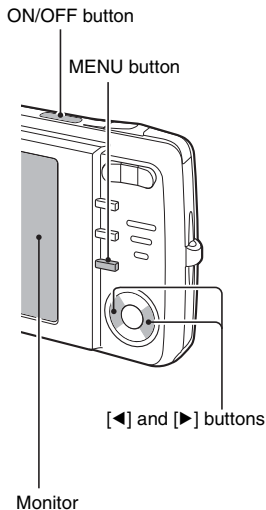

HINT

- You can also adjust the monitor brightness by selecting "BRIGHTNESS" from the Option Menu.

BEFORE TAKING PICTURES

Hints for taking pictures

Muting the camera sounds

- The operation sounds that are generated, for example, when the shutter button, MENU button or SET button is pressed, can be muted.

Where is the image data saved?

- All the image and sound data is recorded in the camera's internal memory or on the card installed in the camera.
- When a card is installed in the camera, the data is recorded on the card. If no card is installed, the data is recorded in the camera's internal memory.

Taking pictures in backlight conditions...

- When taking pictures with the light coming from behind the subject, due to the characteristics of the CCD, light lines or ghost patterns (flare effect) may appear in the captured image. In this situation, it is recommended that you avoid taking pictures with the subject lit from behind.

Switching the guidance display ON/OFF

- Press the [◀] button. Each time the [◀] button is pressed, the guidance display switches between ON and OFF.

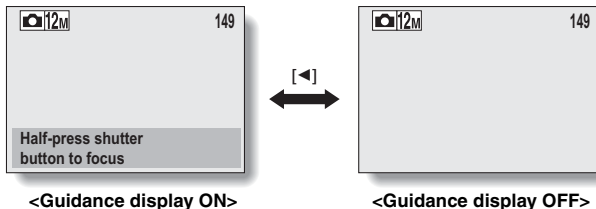

HINT

- Images captured in the still image shooting mode can be rotated when they are played back.
- When the optical zoom is used or when the autofocus is operating, the image may appear to waver, but this is not a malfunction.

CAPTURING AND PLAYING BACK STILL IMAGES

There are two modes for capturing still images. In the single-shot mode, one image is captured each time the shutter button is pressed. In the sequential shots mode, when you press the shutter button, several successive images are captured. For more information about taking sequential shots, please see page 28.

Shooting single shots

- 1 Set the camera to the single-shot mode (page 22).**

- 2 Rest your finger on the shutter button.**
 - Engage the autofocus by pressing the shutter button halfway (focus lock).

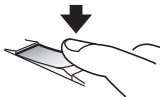

- 3 Gently press the shutter button.**
 - Press the shutter button gently, taking care not to move the camera.
 - The image that was captured appears on the monitor as long as the shutter button is kept pressed (post view).

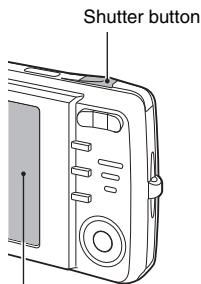
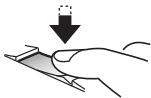

Single-shot icon

<Single-Shot Screen>

CAPTURING AND PLAYING BACK STILL IMAGES

4 Release your finger from the shutter button.

- The captured image is recorded.

HINT

About the target mark

- A target mark  on the monitor shows the area the camera is focusing on.
- The camera automatically determines the correct focus by measuring from 9 different focus points within the shooting area. If the target mark is at a position that is different from the point you wish to focus on, you can refocus, for example, by changing the shooting angle.
- The large target mark appears when the camera focuses on a wide area in the center of the screen.

About the focus indicator

- A green focus indicator appears when the subject is successfully focused, or a red focus indicator when the camera was not able to focus the subject.

The shutter speed and aperture are displayed

- The shutter speed and aperture settings are also displayed on the monitor. You can use them as a reference when shooting.

If the motion alert icon appears...

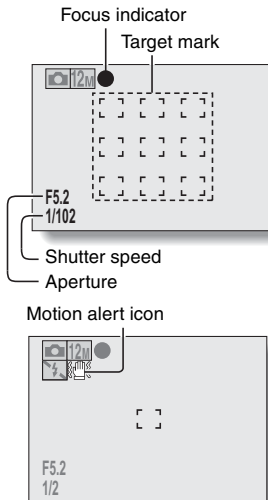

- During still image shooting, if the shutter speed is slow and the possibility that the image may be blurred due to camera shake becomes high, the motion alert icon may appear on the monitor. In this case, use a tripod to stabilize the camera when shooting, or set the flash operation mode to automatic (page 50).
- When shooting with the fireworks  scene function, the motion alert icon always appears, but this is normal.



Shooting sequential shots

When the shutter button is pressed, still images are captured in succession.

- 1 Set the camera to the sequential shots mode or the high-speed sequential shots mode (page 22).

: Sequential shots icon
: High-speed sequential shots icon

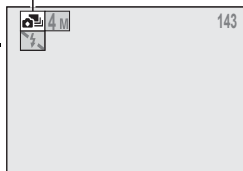

- 2 Press the shutter button to start shooting.
 - Shooting sequential shots begins.

■ Estimated maximum number of sequential shots

<Sequential shots mode>

Resolution	Max. no. of shots
12M	Approx. 3 shots
9M	Approx. 4 shots
6M	Approx. 7 shots
4M	Approx. 11 shots
2M	Approx. 22 shots
0.3M	Approx. 121 shots

<High-speed sequential shots mode>

Resolution	Max. no. of shots
4M	Approx. 25 shots

- The quantities indicate the number of shots when the compression rate is set to **FINE**.
- The maximum number of sequential shots will differ depending on the subject.
- Note that if the shutter button is released during shooting, shooting stops immediately.

CAPTURING AND PLAYING BACK STILL IMAGES

HINT

About the focus when shooting sequential shots

- When sequential shots are captured, the autofocus operates when the focus lock is activated, fixing the focus.

Can the self-timer and/or flash be used?

- The self-timer and flash do not operate when shooting sequential shots.
- The following scene functions cannot be set.

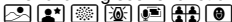

Viewing still images

The steps for viewing both single shots and sequential shots are the same.

1 Press the playback button [▶].

- If the playback button [▶] was pressed to turn the camera on, however, press the playback button [▶] for at least 1 second.
- The image most recently captured appears on the monitor.

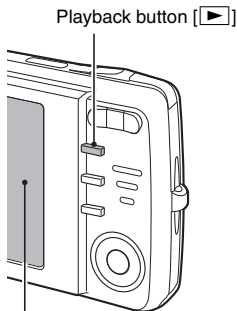

2 View other images.

- Press the [◀] or [▶] button to display the previous or next image.

To display the previous image:

Press [◀].

To display the next image:

Press [▶].

- To return to the Shooting Screen, press the playback button [▶].

<If the camera was turned on by pressing the playback button [▶]>

- When the playback button [▶] or ON/OFF button is pressed, the camera turns off.



When you are finished viewing images...

- Press the ON/OFF button to turn the camera off.

HINT

For still images with voice memo (pages 42 and 43)...

- When the shutter button is pressed, the voice memo is played back.

CAPTURING AND PLAYING BACK STILL IMAGES

9-image/20-image display playback

1 Press the playback button [▶].

2 Press [W] ([📷]) on the zoom switch.

- The 9-image display appears.

3 Select the image to play back.

- Press the arrow buttons to move the orange frame to the desired image, and press the SET button. Instead of pressing the SET button, you can press [T] ([🔍]) on the zoom switch to show the image full screen.
- If [W] ([📷]) on the zoom switch is pressed while the 9-image display is shown, the display changes to the 20-image display.

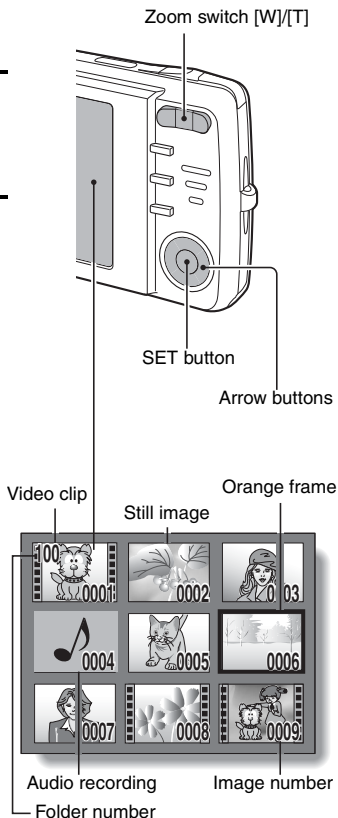

Folder playback

A convenient way to search through multiple folders, or to search for an image that was recorded using Screen Capture.

1 Access the 9-image display screen (page 31).

2 Press [W] ([]) on the zoom switch 2 times.

- The screen to select the playback folder appears.
- If [T] ([]) on the zoom switch is pressed, the camera changes to the 20-image display (page 31).

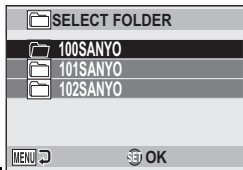

3 Select the desired folder, and press the SET button.

- The first image in the selected folder is displayed.
- At this time, if you press [W] ([]) on the zoom switch, the images in the selected folder are shown in the 9-image display.

CAPTURING AND PLAYING BACK STILL IMAGES

Magnifying (zooming in) the image

1 Display the image that you want to magnify.

- 2** Press [T] ([🔍]) on the zoom switch.
- Magnification is enabled.
 - The image is magnified, and the central portion of image is displayed.
 - Press the arrow buttons to view different parts of the magnified image.

To magnify:

Magnification increases with each press of [T] ([🔍]) on the zoom switch.

To go back:

Magnification decreases with each press of [W] ([🔍]) on the zoom switch.

- Press the SET button to return to the normal (100%) view.

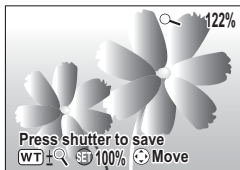

HINT

The magnified portion of the image can be saved as a separate image

- Press the shutter button. The magnified portion is saved as a new still image.

Zoom jump playback

You can magnify a portion of a still image to check the accuracy of the focus.

1 Display a still image to view using zoom jump playback.

2 Press the SET button.

- The image is magnified.
- If the magnified view appears to be in focus, then the overall image will be in focus.

3 Press the arrow buttons to move to the part you wish to magnify, and press [T] ([🔍]) on the zoom switch.

- The displayed area is further magnified.

To magnify further:

Magnification increases with each press of [T] ([🔍]) on the zoom switch.

To go back:

Magnification decreases with each press of [W] ([📐]) on the zoom switch.

- Press the SET button again to return to the normal size (100%) screen.

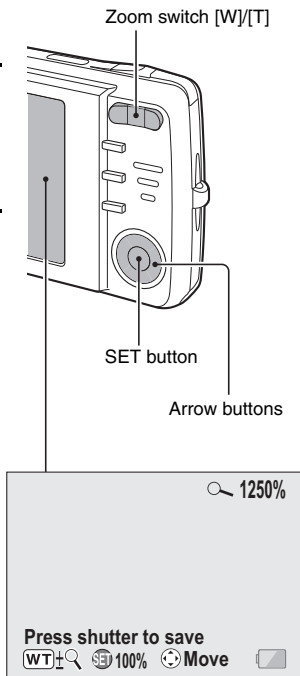

CAPTURING AND PLAYING BACK STILL IMAGES

Deleting files

You can delete files if you no longer need them. You can delete the files one at a time, or all at once.

- 1 To delete files from the card, perform the delete procedure with the card installed in the camera. To delete files from the camera's internal memory, remove the card before performing the delete procedure.**

- 2 Set the camera to the playback mode, and press the [▲] button.**
 - The Delete Screen appears.

DELETE SINGLE:

Deletes one file at a time.

DELETE ALL:

Deletes all the files.

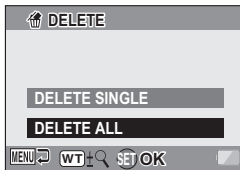

- 3 Delete the files.**

<To delete one file>

- Use the [◀] and [▶] buttons to display the file you wish to delete.
- Press the [▲] or [▼] button to select "DELETE SINGLE".
 - There is no confirmation screen when deleting single files. Before pressing the SET button in step ③, please make sure that the displayed image is one you wish to delete.
- Press the SET button.
 - The currently displayed file is deleted.
 - To delete other files, repeat steps ① to ③.

<To delete all the files>

- ① Use the [◀] and [▶] buttons to view the images and check if it is OK to delete all the files.
- ② Press the [▲] or [▼] button to select "DELETE ALL".
- ③ Press the SET button.
 - The Delete Confirmation Screen appears. To delete the files, select "YES", and press the SET button. When the file delete is completed, "No image" is shown.

CAUTION

About protected images

- Files that are protected from accidental delete cannot be deleted. To delete protected files, set the protect setting for the file to off, and then follow the file delete procedure.

VIDEO CLIP RECORDING AND PLAYBACK

Recording a video clip

1 Set the camera to the video clip recording mode (page 22).

2 Press the shutter button.

- Video clip recording begins. During recording, the length of the video clip and the remaining recording time available are shown on the monitor.
- It is not necessary to continue pressing the shutter button while recording.

3 End the recording.

- Press the shutter button again to stop recording and save the video clip.

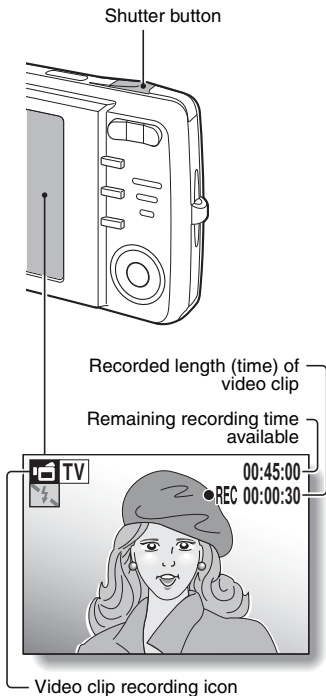

Playing back the video clip

4 Press the playback button [▶].

- If the playback button [▶] was pressed to turn the camera on, however, press the playback button [▶] for at least 1 second.
- The video clip just recorded appears on the monitor.

5 Press the SET button.

- Video clip playback begins.
- To stop playback, press the [▼] button.

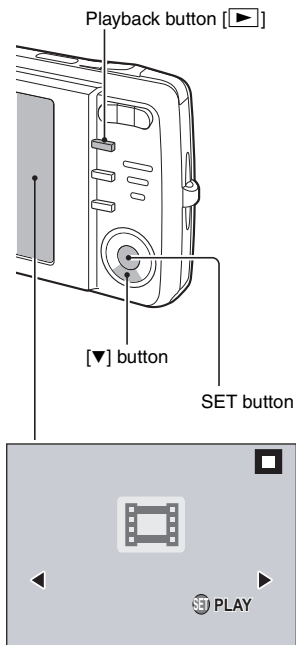

VIDEO CLIP RECORDING AND PLAYBACK

Outline of playback operation

To do this...		Do this
Stop playback		During playback, press the [▼] button.
Pause		During playback, press the SET button. During accelerated or slow playback, press the [▲] button.
To extract a still image		While playback is paused, press the shutter button.
To play back one image at a time (single-frame step)	Forward	While playback is paused, press the [▶] button.
	Reverse	While playback is paused, press the [◀] button.
Slow playback	Forward	While playback is paused, press and hold the [▶] button.
	Reverse	While playback is paused, press and hold the [◀] button.
To accelerate playback	Forward	During forward playback, press the [▶] button. • The playback speed changes each time the [▶] button is pressed, as follows: Normal playback → 2× → 5× → 10× → 15× Press the [◀] button to resume normal playback speed.
	Reverse	During forward playback, press the [◀] button. • The playback speed changes each time the [◀] button is pressed, as follows: 15× ← 10× ← 5× Press the [▶] button to resume normal playback speed.
Return to normal playback speed		Press the SET button.
Adjusting the volume		Louder: During playback, press [T] on the zoom switch. Softer: During playback, press [W] on the zoom switch.

When you are finished viewing video clips...

- Press the ON/OFF button to turn the camera off.

CAUTION

How to save one frame from a video clip as a still image

- ① Play back the video clip. Pause the playback at the point you wish to “snap” a photo.
- ② Press the shutter button.
 - The currently displayed frame is saved as a still image.

The data for a video clip is very large

- Therefore, be aware that if the video clip is uploaded to a computer to be played back, the computer may not be able to play back the video fast enough, making it appear jerky. (The video will always be displayed properly on the camera monitor.)

If video clip recording stops even when there is card memory remaining...

- Depending on the card you are using, recording may stop even if there is remaining memory in the card.
- For video clip recording, it is recommended that a high-speed memory card be used.

If no audio is heard...

- The audio is not played back when the video clip is played back in the frame-by-frame, slow playback, fast playback or reverse playback mode.

During video clip playback, the sound of a motor is audible...

- During recording, the sound of the optical zoom movement or autofocus movement was recorded. This is not a malfunction.

Does video clip playback stop when you adjust the volume?

- If you adjust the volume during video clip playback, the playback may temporarily pause. This is not a malfunction.

USING THE SCENE FUNCTION

You can select from a variety of preset settings (aperture, shutter speed, etc.) for specific shooting conditions.

- 1 Set the camera to the recording mode (page 21), and press the **SCENE** button.

- The screen to select a scene function appears.

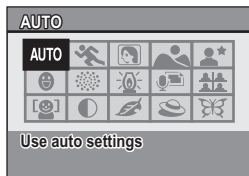

- 2 Use the arrow buttons to select the desired setting.

<Example: In the single-shot mode>

<Features of each scene function>

Scene function	Features	Recording mode setting			
Auto	The camera makes the optimum settings.	<input type="radio"/>	<input type="radio"/>	<input type="radio"/>	<input type="radio"/>
Sports	Capture a split-second image of a fast-moving subject.	<input type="radio"/>	<input type="radio"/>	<input type="radio"/>	<input type="radio"/>
Portrait	Enhance the three-dimensional feel of the subject by blurring the background. (With face chaser function)	<input type="radio"/>	<input type="radio"/>	<input type="radio"/>	<input type="radio"/>
Landscape	For beautiful shots of distant scenery.	<input type="radio"/>	<input checked="" type="radio"/>	<input checked="" type="radio"/>	<input type="radio"/>
Night view portrait	Photograph the subject while keeping the background night scenery.	<input type="radio"/>	<input checked="" type="radio"/>	<input checked="" type="radio"/>	<input type="radio"/>
Smile detection	Capture a photo at the instant the subject smiles.	<input type="radio"/>	<input checked="" type="radio"/>	<input checked="" type="radio"/>	<input checked="" type="radio"/>
Fireworks	For capturing fireworks at night.	<input type="radio"/>	<input checked="" type="radio"/>	<input checked="" type="radio"/>	<input type="radio"/>

Scene function	Features	Recording mode setting			
Lamp	Photograph in low-light conditions.	○	×	×	○
Still image with audio	Shoot a still image and add a voice memo.	○	×	×	×
Best shot	Four successive still images are captured as the exposure changes.	○	×	×	×
Face chaser	The subject's face is kept in focus and the exposure adjusted as the image is captured.	○	○*	○*	○*
Monochrome	Create black-and-white photos.	○	○	○	○
Sepia	Create sepia-tone photos.	○	○	○	○
Contrast	Accentuates the light and dark areas in the image.	○	○	○	○
Vivid	Accentuates the colors in the image.	○	○	○	○

○: Available ×: Not available

*: Disabled during recording

3 Press the SET button.

- This completes the scene select setting.
- The display returns to the Shooting Screen.
- The scene function setting is shown on the monitor.

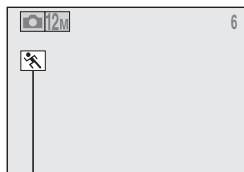

Scene function setting
(is not displayed)

USING THE SCENE FUNCTION

Capture a still image with a voice memo

With the still-image-plus-audio  scene function, you can add an audio track (about 10 seconds maximum) to a captured still image. This audio track is called a “voice memo”.

1 On the screen to select a scene function (page 41), select , and press the SET button.

2 Press the shutter button to take the picture, then speak into the microphone.

- During recording, be careful not to obstruct the microphone with your fingers, for example.
- Audio recording begins. During recording, the length of the audio track and the remaining recording time are shown on the monitor.
- The maximum recording time for a voice memo is about 10 seconds.
- To end the recording before 10 seconds has elapsed, press the shutter button.

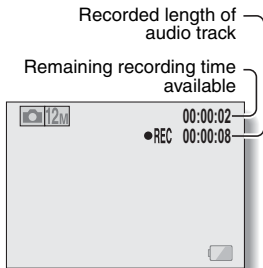

How to use the best shot feature

- 1** Set the camera to the single-shot mode; on the screen to select a scene function (page 41), select ; and press the SET button.

- 2** Press the shutter button.
 - While the settings change, four still images are shot in sequence.
 - After the images are captured, the four still images are displayed on the monitor.

<To save all four images>

 - With all four images showing on the monitor, press the MENU button.



- 3** Use the arrow buttons to move the orange frame to the image you wish to save.
 - For a full-size view of the selected image, press the SET button.
 - With the full-size view active, you can use the [◀] and [▶] buttons to view the previous or next image.
 - To return to the screen in step 2, press the MENU button.

- 4** With the full-size view of the image you wish to save, select "YES", and press the SET button.
 - The image currently displayed is saved, and the other images are deleted.



USING THE SCENE FUNCTION

How to use the face chaser feature

To attain the best possible face shots, the camera automatically focuses on the face and adjusts the exposure.

1 On the screen to select a scene function (page 41), select , and press the SET button.

2 Aim the camera lens at the subject.

- The camera searches for the subject's face. When it detects the face, a green frame appears.
- Do not touch the shutter button while the camera is searching. The camera cannot search when the autofocus is activated.

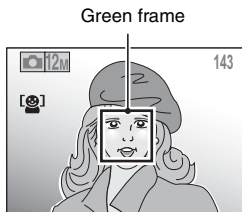

3 The focus locks on the subject (page 26).

- The camera focuses on the subject and the exposure is adjusted.
- When the face is in focus, the green frame changes to orange.

4 Press the shutter button.

- The image is captured.

CAUTION

- The digital zoom is disabled.
- The face chaser function does not work when zooming in or out.
- The face chaser function may not work when the subject's face in the monitor is relatively small or appears dark.

For images captured using the face chaser feature

- On the Playback Screen, when zooming in, the face that was defined by the double frame during capture becomes the zoom center.

How to shoot using Smile Detection

Capture a photo at the instant the subject smiles.

Normal shooting

1 On the screen to set the scene function (page 41), select , and press the SET button.

2 Aim the camera lens at the subject.

- The camera searches for the subject's face. When it detects the face, a green frame appears. The image is automatically captured when the subject smiles.

Selecting the shooting area of the desired subject

From the multiple faces, select the area that frames the targeted face, and capture the image when the selected subject smiles.

1 On the screen to set the scene function (page 41), select , and press the SET button.

2 Aim the camera lens at the subject.

3 Press the SET button.

- An orange frame appears, and the screen for you to select the area that encompasses the target subject's face appears.

USING THE SCENE FUNCTION

- 4** Use the arrow buttons to move the orange frame to the area that encompasses the target subject's face.

5 Press the SET button.

- The orange frame changes to yellow, and the Smile Detection area is fixed.
- The camera adjusts the focus and exposure for the framed face.
- When the face is in focus, the green frame changes to a double frame.
- The image is automatically captured when the subject in the selected area smiles.

HINT

The camera can't detect the smiling face?

- The camera cannot detect the subject's smile when zooming in or out.
- Smile Detection may not work accurately when the face in the monitor appears small or dim.

For best results with Smile Detection

- Smile Detection works best when the subject is directly facing the camera and showing his/her teeth when smiling.

Can't use the self-timer?

- The self-timer cannot be used with Smile Detection.

To cancel Smile Detection...

- Select a different scene function.

OTHER RECORDING FUNCTIONS

Using the zoom

Your camera has two zoom functions: optical zoom and digital zoom.

1 Set the camera to the recording mode (page 21), and point the camera lens at the subject.

2 Press the zoom switch to compose the desired image.

[T]: Zoom in on the subject.

[W]: Zoom out.

- When the zoom switch is pressed, the zoom bar appears on the monitor.
- When the optical zoom factor is at maximum, zooming stops temporarily. When [T] on the zoom switch is pressed again, the mode changes to the digital zoom mode and zooming continues.



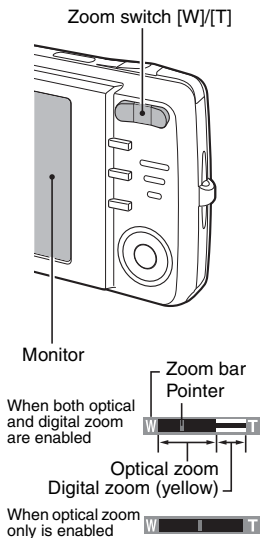

3 Take the picture.



OTHER RECORDING FUNCTIONS

HINT

Can't access the digital zoom?

- The digital zoom cannot be used when the face chaser , smile detection  or portrait mode  scene function is active, or the focus mode is set to AF seeker .

Can't access the optical zoom?





- When the focus range is set to pan  or during video clip recording, the optical zoom cannot be used.

Flash setting

The flash is used not only for taking pictures where there is insufficient light, but also when the subject is in shade or in backlight conditions. Your camera's flash has four modes of operation (auto mode, forced flash mode, flash off mode and red-eye reduction mode). Select the flash mode that is appropriate for the surrounding conditions. The flash can be enabled only when taking single-shot still images.

1 Set the camera to the single-shot mode (page 22), and press the [▲] () button.

- The flash menu appears.

- : The camera will detect the subject brightness and use the flash only when required. In a backlight situation, if only the center of the image is very dark, the flash will operate to compensate (auto).
- : The flash will operate with every image captured regardless of the conditions. Use this setting under backlight conditions, when the subject is in shade, under fluorescent lighting conditions, etc. (forced flash).
- : The flash will not operate even in dark situations. Use this setting when capturing an image in a location where flash photography is prohibited, or when shooting a night landscape scene (flash off).
- : The digital camera will detect the subject brightness and use the flash only when required. At this time the flash will operate in a manner that reduces the red reflection ("red-eye") in the subject's eyes (red-eye reduction).

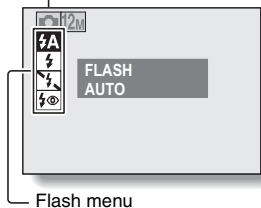
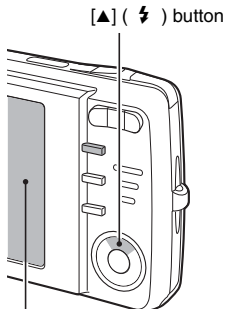

OTHER RECORDING FUNCTIONS

- 2** Press the [▲] or [▼] button to select the desired flash mode, and press the SET button.



- 3** Press the shutter button.
- The picture is snapped and the flash operates according to the selected mode.

HINT

When auto is selected...

- The  icon indicating the flash setting is not shown on the Shooting Screen.



When auto or red-eye reduction is selected...

- When the shutter button is pressed, if the camera determines that the flash is necessary, a  or  icon appearing on the monitor indicates that the flash will operate.

Self-timer

Self-timer photography is available in the single-shot mode.

- 1 Set the camera to the single-shot mode (page 22), and press the [▶] (⏻) button.**

- The self-timer menu appears.
- : The image is captured about 2 seconds after the shutter button is pressed.
- : The image is captured about 10 seconds after the shutter button is pressed.

- 2 Use the [▲] and [▼] buttons to select the desired self-timer setting, and press the SET button.**

- The self-timer is set, and you are returned to the Shooting Screen.

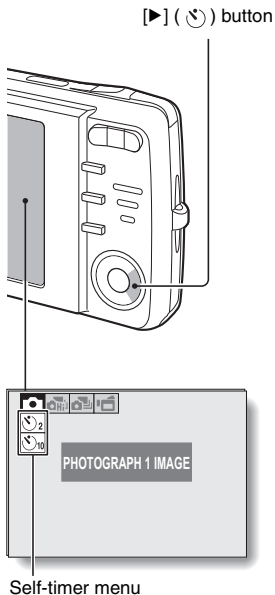

OTHER RECORDING FUNCTIONS

HINT

- The countdown time until shutter release is shown graphically on the monitor.

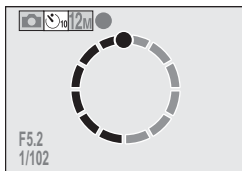

To pause or cancel the self-timer function...

- If the shutter button is pressed again before the shutter is released, the self-timer countdown temporarily stops. Press the shutter button one more time to restart the self-timer.
- To cancel self-timer photography, set the self-timer setting to off .
- After the self-timer picture is snapped, the self-timer is automatically reset to off.

When is selected...

- When the shutter button is pressed, the self-timer indicator flashes for approximately 10 seconds, after which shooting begins.
- About 3 seconds before shooting, the self-timer indicator flashes faster.

Self-timer indicator

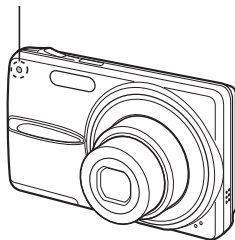

Focus range

- 1 Set the camera to the recording mode (page 21), and press the [▼] (👁) button.

• The focus range menu appears.

[PF]: The focus operates within the ranges shown below (pan).

<Still image shooting>

- At maximum aperture setting:
2.5 m (8.20 ft.) to ∞
- At minimum aperture setting:
2 m (6.56 ft.) to ∞

<Video clip recording>

- Wide end:
At maximum aperture setting:
80 cm (31.50 in.) to ∞
At minimum aperture setting:
52 cm (20.47 in.) to ∞
- Tele end:
At maximum aperture setting:
3.3 m (10.83 ft.) to ∞
At minimum aperture setting:
2.2 m (7.22 ft.) to ∞

[👤]: The camera automatically focuses on the subject within a range of 10 cm (3.94 in.) (Wide end) or 60 cm (23.62 in.) (Tele end) to infinity (auto).

[👁]: You can focus on a subject within the following ranges (macro):
Wide end: 5 cm (1.97 in.) to 80 cm (31.50 in.)
Tele end: 60 cm (23.62 in.) to 80 cm (31.50 in.)

[MF]: The focus can be manually set to any distance from 5 cm (1.97 in.) to 8 m (26.25 ft.), as well as to infinity (manual).

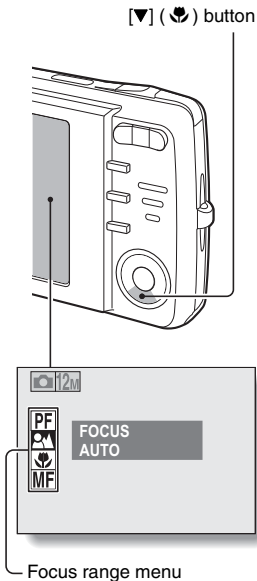

OTHER RECORDING FUNCTIONS

2 Press the [▲] or [▼] button to select the desired focus range, and press the SET button.

- The specified focus range is set, and the camera returns to the Shooting Screen.

HINT

- In the single-shot mode and sequential shots mode, when the focus range is set to macro , the zoom is automatically set to one step from the wide end. When the focus range is set to pan [PF], the zoom is automatically set to the Wide end.

How to use the manual focus

1 Select manual **[MF]** from the focus range menu, and press the **SET** button.

- The focus distance adjustment bar appears.

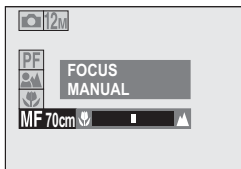

2 Press the **[◀]** or **[▶]** button to adjust the focus distance, and press the **SET** button.

- The focus distance is set, and you are returned to the Shooting Screen.

HINT

About the focus range

- The focus distance indication shows the distance between the lens surface and the subject.
- In some cases there may be a slight variance between the distance (numerical figure) you set in the manual focus mode and the actual distance. Use the monitor to confirm the focus and compose the photo.

About zoom movement when using the manual focus

- If the focus distance is set to 50 cm (19.69 in.) or less, the zoom changes to the largest setting that is suitable for that focus distance.
- When the focus distance is set to 50 cm (19.69 in.) or less, the zoom will function only within the range at which the image is focused.

ACCESSING THE MENUS

Detailed camera settings are accessed from the menus.

How to display the menus

1 Turn on the camera, and set it to the recording or playback mode.

- Set the camera to the recording mode to display the Recording Menu, or the playback mode to display the Playback Menu.

2 Press the MENU button.

- The menu for the mode specified in step 1 appears.

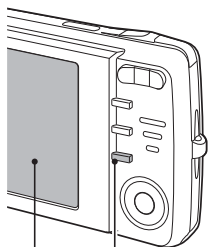

MENU button

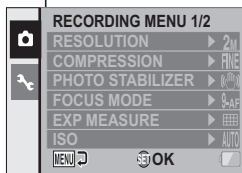

Exit the menu

Press the MENU button to exit the menu.

How to operate the menus

Use the arrow buttons to select the item you wish to change, press the SET button, and the corresponding screen will appear.

1 Display the menu (page 57).

2 Select the or tab. Display the Recording Menu:

Select the  tab.

Display the Playback Menu:

Select the  tab.

Display the Option Menu:

Select the  tab.

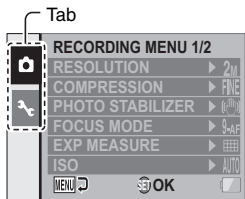

<Example: Recording mode>

3 Press the [▶] button.

4 Press the [▲] or [▼] button to select an item to set.

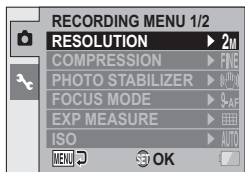

5 Press the SET button.

- The Setting Screen appears.
- Press the [▲] or [▼] button to select the desired setting, and then press the SET button to complete the setting.
- To cancel the menu, press the MENU button.

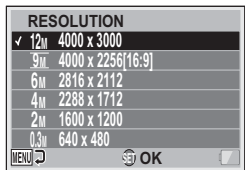

<Example: When
"RESOLUTION" is selected>

SPECIFICATIONS

Camera

Image file format	<p>Still images: JPEG format (DCF, DPOF, Exif 2.2 compliant)</p> <p>Note: Designed mainly by the Japan Electronics and Information Technology Industries Association (JEITA), DCF (Design rule for Camera File system) is standard for digital still camera image files to provide interoperability between digital photography devices for the images stored on removable memory cards. However, it is not guaranteed that all devices will support the DCF standard.</p> <p>Video clips: QuickTime Movie (Photo-JPEG)</p> <p>Audio recordings: WAVE format (monaural)</p>
Data storage media	Internal memory: Approx. 50 MB External memory: SD Memory Card (equivalent to a 32 GB SDHC Memory Card)
Camera effective number of pixels	Approx. 12.1 million pixels
Image sensor	1/2.3-inch (1.1 cm) CCD Virtual number of pixels: Approx. 12.5 million pixels, interlace scan, primary color filter
Recording resolution	<p><Still image shooting></p> <p>12M: 4000 × 3000 pixels</p> <p>9M: 4000 × 2256 pixels (16:9 aspect ratio)</p> <p>6M: 2816 × 2112 pixels</p> <p>4M: 2288 × 1712 pixels</p> <p>2M: 1600 × 1200 pixels</p> <p>0.3M: 640 × 480 pixels</p> <p><Video clip recording></p> <p>TV: 640 × 480 pixels, 30 frames/second</p> <p>WEB: 320 × 240 pixels, 15 frames/second</p>
White balance	Full-auto TTL; manual setting available

Lens	3.0x optical zoom lens	f=6.3 mm to 18.9 mm (35 mm film camera conversion: 35 mm to 105 mm) Autofocus, 5 groups, 6 elements (4 with aspheric surfaces)
Aperture	Open F=3.1 (Wide) to 5.9 (Tele)	
Exposure control type	Programmable AE Exposure correction available from the Recording Menu (0±1.8EV in 0.3EV steps)	
Light-measuring modes	Multi-section measuring, center-weighted measuring, spot measuring	
Range	Normal photography: 10 cm (3.94 in.) to ∞ (Wide), 60 cm (23.62 in.) to ∞ (Tele) Macro photography: 5 cm (1.97 in.) to 80 cm (31.50 in.) (Wide), 60 cm (23.62 in.) to 80 cm (31.50 in.) (Tele)	
Digital zoom	For shooting: 1x to 4x For playback: 1x to 62.5x (varies with resolution)	
Shutter speed	Single-shot mode: 1/2 to 1/1,500 sec. (Maximum approx. 2 seconds when the scene function is set to fireworks  etc.) (During flash: 1/30 to 1/1,500 sec.) Sequential shots mode: 1/2 to 1/1,500 sec. Video clip recording mode: 1/30 to 1/2,500 sec.	
Sensitivity (standard output sensitivity)	Single-shot mode/sequential shots mode (standard output sensitivity): Auto (ISO 64 to 400)/ISO 64, ISO 100, ISO 200, ISO 400, ISO 800, ISO 1600, ISO 3200, and ISO 6400 (switchable from Recording Menu) Video clip recording mode: Auto (ISO 384 to 2400) * Sensitivity measured in compliance with the ISO standard (ISO 12232:2006).	

SPECIFICATIONS

Monitor	2.7-inch (6.9 cm) TFT color LCD Approx. 230,000 pixels (Frame coverage: Approx. 100%) Brightness adjustment: 5-step	
Flash working range	GN = 5.2 Approx. 60 cm (23.62 in.) to 3.3 m (10.83 ft.) (Wide) Approx. 60 cm (23.62 in.) to 1.7 m (5.58 ft.) (Tele)	
Flash modes	Auto-flash, forced flash, flash off, red-eye reduction	
Focus	TTL-type AF (9-point range finder/spot focus/AF seeker), manual focus (14 steps)	
Self-timer	Approx. 2-second delay, 10-second delay	
Ambient environment	Temperature	0 to 40 °C (32 to 104 °F) (operation), -20 to 60 °C (-4 to 140 °F) (storage)
	Humidity	30 to 90% (operating, no condensation) 10 to 90% (storage, no condensation)
Power supply	Lithium-ion battery pack (DB-L80) × 1	
Dimensions (at narrowest part, not including grip or lens protrusion)	92.8 (W) × 55.2 (H) × 17.0 (D) mm 3.65" (W) × 2.17" (H) × 0.67" (D)	
Weight	Approx. 97 g (3.42 oz.) (camera only [without battery pack and card]) Approx. 114 g (4.02 oz.) (including battery pack and card)	

Camera connectors

USB/AV (communication/audio and video output) terminal	Dedicated regrouped jack	
	Audio output	180 mVrms (-12 dBs), 2.2 k Ω or less, monaural
	Video output	1.0 Vp-p, 75 Ω unbalanced, sync negative, composite video, NTSC color TV system/PAL TV system (switchable from the Option Menu)
	USB	USB 2.0 Full Speed PC camera: USB video class

Battery life

Maximum recording time	170 images: CIPA standard (when a Toshiba 128 MB SD Memory Card is used)
Maximum playback time	310 minutes: LCD monitor on, continuous playback

- Until battery pack runs out when using a fully charged battery pack at a 25 °C (77 °F) ambient temperature.
- The operation time may vary depending on the conditions of the battery pack and the conditions of use. Especially when used at temperatures below 10 °C (50 °F), the battery pack operation time is drastically reduced.

SPECIFICATIONS

Possible Number of Images/Video Recording Time/Audio Recording Time

Recording mode setting	Resolution setting	Compression rate setting	Internal memory	SD Memory Card	
				2 GB	8 GB
Single-shot mode/ Sequential shots mode	12M	FINE	12 images	502 images	1,960 images
		NORM	19 images	754 images	2,950 images
	9M	FINE	17 images	665 images	2,600 images
		NORM	25 images	997 images	3,900 images
	6M	FINE	26 images	1,010 images	3,970 images
		NORM	38 images	1,500 images	5,900 images
	4M	FINE	39 images	1,500 images	5,900 images
		NORM	58 images	2,200 images	8,650 images
	2M	FINE	79 images	3,090 images	12,100 images
		NORM	118 images	4,410 images	17,300 images
	0.3M	FINE	399 images	15,400 images	60,500 images
		NORM	532 images	20,600 images	80,700 images
Video clip recording mode	TV	—	28 sec.	18 min. 10 sec.	1 hr. 11 min.
	WEB	—	2 min. 30 sec.	1 hr. 36 min.	6 hr. 19 min.
Audio file mode	—	—	26 min. 30 sec.	17 hr. 10 min.	67 hr. 10 min.

- Up to 9 hours of continuous audio recording is possible.
- When recording a video clip using an 8 GB card, recording terminates when the size of the file currently being recorded reaches approx. 4 GB.
- The values were determined using an SD Memory Card by Sandisk.
- Even with cards of the same capacity, the amount of data that can actually be stored may differ depending on the card brand, etc.
- The continuous shooting time for each video clip will differ depending, for example, on the card capacity, environmental conditions (temperature and shooting conditions, etc.).

Supplied battery pack charger

Part No.		VAR-L80
Power source		AC 100 to 240 V, 50 to 60 Hz, 5 W
Rated output		DC 4.2 V, 550 mA
Compatible batteries		Supplied or separately sold Lithium-ion battery pack (DB-L80)
Ambient environment	Temperature	0 to 40 °C (32 to 104 °F) (recharge), -20 to 60 °C (-4 to 140 °F) (storage)
	Humidity	20 to 80% (no condensation)
Dimensions		84 (W) × 22.5(H) × 50.5 (D) mm 3.31" (W) × 0.89" (H) × 2.00" (D)
Weight (without power cord)		Approx. 49 g (1.73 oz.)
Power cord rated value	VPC-X1250	AC 125 V, 7 A
	VPC-X1220EX	AC 250 V, 2.5 A

- The VPC-X1220GX and VPC-X1220PX models are supplied with a power cord that is appropriate for the region of destination.
- When using the supplied battery pack charger abroad, the power cord may need to be replaced in accordance with local requirements. Please contact your local dealer for details.

Supplied Li-ion battery pack

Model number		DB-L80
Voltage		3.7 V
Capacity		700 mAh
Ambient environment	Temperature	0 to 40 °C (32 to 104 °F) (during use) -10 to 30 °C (14 to 86 °F) (storage)
	Humidity	10 to 90% (no condensation)
Dimensions		39.2 (W) × 5.9 (H) × 31.4 (D) mm 1.54 (W) × 0.23 (H) × 1.24 (D) in.
Weight		Approx. 15 g (0.5 oz.)

SPECIFICATIONS

Others

Mac OS and QuickTime are trademarks of Apple Inc., registered in the U.S. and other countries.

Microsoft and Windows are registered trademarks of Microsoft Corporation in the USA and other countries.

Intel and Pentium are registered trademarks of Intel Corporation (USA). In this manual, the Microsoft® Windows® 2000 operating system, Microsoft® Windows® XP operating system, Microsoft® Windows® Vista operating system, and Microsoft® Windows® 7 operating system are collectively referred to as "Windows".

SDHC logo is a trademark.



All other company and product names are registered trademarks or trademarks of their respective owners.

CAUTION

- It is forbidden to copy this manual, whole or in part, without prior written permission.
- All images and illustrations given in this manual are for explanation purposes and may differ slightly from that of the actual product. Also, actual specifications are subject to change without prior notice and therefore may differ from the contents of this manual.

Before capturing those important shots, be sure to first take a test shot to confirm that your camera is set up and ready to go

- Sanyo Electric shall not be held responsible for any problems resulting from the use of this camera.
- Sanyo Electric declines all responsibility for damages due to improper use of the camera, failure to adhere to the instructions given in this manual, or repairs or changes done by those other than a technician authorized by the manufacturer.
- Sanyo Electric shall not be held responsible for any damage caused by optional devices or consumable items used with the camera other than those supplied with the camera or those specified by Sanyo Electric.
- Sanyo Electric shall not be held responsible for any losses or loss of revenue resulting from the loss of data caused by the malfunction, or the repairing of a malfunction, of the camera.
- The images captured with this camera will differ in quality from pictures taken with a standard film camera.

SANYO

SANYO Electric Co., Ltd.